

DS

DS100M
Manual 1.4 en



Notes on document version

All previous versions of this document are hereby no longer valid.

Version 1.4:

Matrix I/O License modelling added.

Refer to:

⇒ Chapter 1.1.2 "Matrix I/O License models" on page 5.

⇒ Chapter 3 "Technical specifications" on page 8.

General information

DS100M Manual

Version: 1.4 en, 03/2025, D2049.EN .01

Copyright © 2025 by d&b audiotechnik GmbH & Co. KG; all rights reserved.

Keep this document with the product or in a safe place so that it is available for future reference.

We recommend you to regularly check the d&b website for the latest version of this document.

When reselling this product, hand over this document to the new owner.

If you supply d&b products, please draw the attention of your customers to this document. Enclose the relevant documents with the systems. If you require additional documents for this purpose, you can order them from d&b.

d&b audiotechnik GmbH & Co. KG
Eugen-Adolff-Str. 134, D-71522 Backnang, Germany
T +49-7191-9669-0, F +49-7191-95 00 00
docadmin@dbaudio.com, www.dbaudio.com

Explanation of graphical symbols



The lightning symbol within a triangle is intended to alert the user to the presence of uninsulated "dangerous voltages" within the unit's chassis that may be of sufficient magnitude to constitute a risk of electric shock to humans.



The exclamation point within a triangle is intended to alert the user to the presence of important operating and service instructions in the literature accompanying the product.

Before using this product, carefully read the applicable items of the following safety instructions.

1. Keep these instructions for future reference.
2. Read these instructions.
3. Heed all warnings.
4. Follow all instructions.
5. **WARNING!** To reduce the risk of fire or electric shock:
 - Do not expose this unit to rain or moisture.
 - Keep water or other liquids away from the unit.
 - Do not place liquid filled containers, for example beverages, on top of the unit.
 - Do not operate the unit while it is wet or standing in liquid.
6. Always operate the unit with the chassis ground wire connected to the electrical safety earth.
Do not defeat the safety purpose of a grounding-type plug. A grounding-type plug has two blades and a third grounding prong. The third prong is provided for your safety. If the provided plug does not fit into your outlet, consult an electrician for replacement of the obsolete outlet.
7. Do not use this unit if the power cord is damaged or frayed. Protect the power cord from being walked upon or pinched, particularly at the plugs and the point where it exits from the apparatus.
8. The unit is intended for use in a 19" rack. Follow the mounting instructions. When a rack on wheels is used, exercise caution when moving the loaded rack to avoid injury from tipping over.
9. Unplug this apparatus during lightning storms or when unused for long periods of time.
10. Lay all cables connected to the unit carefully so that they cannot be crushed by vehicles or other equipment and that no one can either step on them or trip over them.
11. Refer all servicing to qualified service personnel. Servicing is required when the apparatus has been damaged in any way such as:
 - Power-supply cord or plug is damaged.
 - Liquid has been spilled into the unit.
 - An object has fallen into the unit.
 - The unit has been exposed to rain or moisture.
 - The unit does not operate normally.
 - The unit was dropped or the chassis is damaged.
 - Do not remove top or bottom covers. Removal of the covers will expose hazardous voltages. There are no user serviceable parts inside and removal may void the warranty.
12. Use the mains plug as the disconnecting device and keep it readily accessible. If the mains plug is not readily accessible due to mounting in a 19" rack, then the mains plug for the entire rack must be readily accessible.
13. An experienced user must always supervise the equipment, especially if inexperienced adults or minors are using the equipment.

1 DS100M Signal Engine	5
1.1 Intended use.....	5
1.1.1 Software Terms of Use.....	5
1.1.2 Matrix I/O License models.....	5
1.1.3 Application.....	6
2 Scope of supply	7
3 Technical specifications	8
4 Startup	10
4.1 Overview.....	10
4.2 Rack mounting and cooling.....	11
4.3 Connections.....	12
4.3.1 Mains connection.....	12
4.3.2 ETH 1/ETH 2.....	12
4.3.3 USB.....	13
4.3.4 AUDIO NETWORK.....	13
4.3.5 MADI interface.....	14
4.4 Controls and indicators.....	15
4.4.1 Mains power switch.....	15
4.4.2 POWER button and LED indicator.....	15
4.4.2.1 Switching on (boot up).....	15
4.4.2.2 Device shut down/Device reset/System status.....	15
4.4.3 ETHERNET indicators.....	17
4.4.4 AUDIO NETWORK indicators.....	17
5 Milan™/MADI interfacing	18
6 Initial setup	19
6.1 Physical setup.....	19
6.2 Direct connection.....	19
6.3 Web Remote interface.....	19
6.4 Web Remote interface page.....	20
6.4.1 Event Log tab.....	20
6.4.2 Commands tab.....	20
6.4.3 Licenses tab.....	21
6.4.3.1 License update.....	21
6.4.4 Service tab.....	22
7 Service/Maintenance and care	23
7.1 Service.....	23
7.2 Maintenance and care.....	23
8 Manufacturer's declarations	24
8.1 Declaration of Conformity.....	24
8.2 WEEE Declaration (Disposal).....	24
8.3 Licenses and Copyright.....	24
8.4 Certifications.....	24

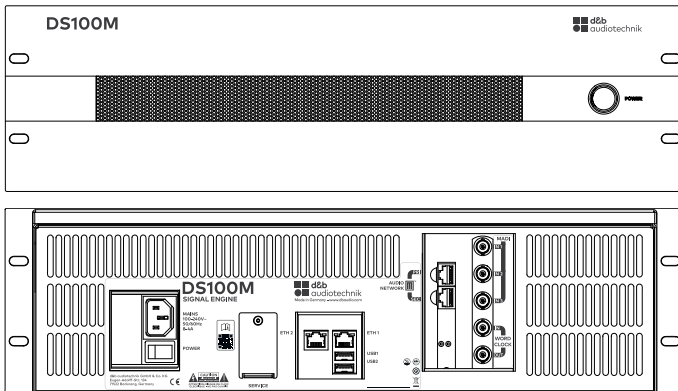

1.1 Intended use

The d&b DS100M Signal Engine is a specialized 3 RU, 19" rack mount audio processor with Milan™ audio networking as well as MADI audio inputs.

In its base configuration, it provides a 64 x 64 level / delay audio matrix. Additional software modules provide dynamic source positioning and emulated acoustics functions.

NOTICE!

The device complies with the electromagnetic compatibility requirements of EN 55032:2019 (product family standard for audio, video, audio-visual and entertainment lighting control apparatus for professional use) for the environment Class B (residential).

Acoustic interferences and malfunctions may occur if the unit is operated in the immediate vicinity of high-frequency transmitters (e.g. wireless microphones, mobile phones, etc.). Damage to the device is unlikely, but cannot be excluded.

1.1.1 Software Terms of Use

The software modules installed on the device shall only be used to the extent intended/documented. d&b shall not be liable for any damage resulting from any other or non-conforming use.

You may not decompile, copy, alter or enhance the software modules installed on the device or their source codes in any form. d&b will investigate any infringement of copyright or intellectual property rights.

1.1.2 Matrix I/O License models

Depending on the running (active) license the following matrix in- and output (in x out) sizes at the given sampling rates applies:

- 64 x 24 @ 48 kHz or 96 kHz
- 64 x 64 @ 48 kHz or 96 kHz
- 128 x 64 @ 48 kHz or 96 kHz

1.1.3 Application

The DS100M Signal Engine is a versatile tool for large and complex audio systems that are used to route and distribute a large number of audio channels to many different amplifier channels, break out rooms, loudspeaker zones or positions.

The DS100M completely integrates with the overall d&b system approach which includes loudspeakers, amplifiers, rigging, transport and the DS20 Audio network bridge, which interfaces between Milan™ audio networking and the AES3 inputs of the d&b amplifiers.

d&b audio systems including the DS100M are designed and optimized using the d&b ArrayCalc Simulation software and are controlled using the d&b R1 Remote control software.

The comprehensive input processing provides Gain, EQ, Delay, Mute and Polarity switches enabling the user to combine all types of input signals to create a mix of audio signals from a wide variety of sources. Extended processing capabilities are also provided on every output.

The audio matrix with level, mute, and delay controls at every crosspoint is a very flexible tool to either simply distribute audio signals to the intended output or, if the crosspoint delay is enabled, to position audio sources in a distributed loudspeaker setup.

Note: Comprehensive information on the "Media integrated local area network" (Milan™) is given in the d&b technical information TI 370, which can be downloaded from the related product page at www.dbaudio.com.

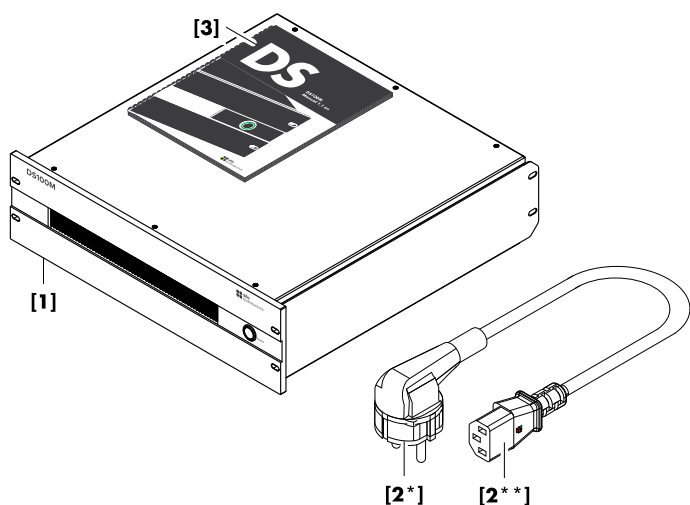

Before starting up the device, please verify the shipment for completeness and proper condition of the items.

If there is any sign of obvious damage to the unit and/or the power cord, do not operate the unit and contact your local dealer from whom you received it.

Pos.	Qty.	d&b Code	Description
[1]	1	Z4102	d&b DS100M Signal Engine
Including:			
[2]	1	Z2611.xxx	Power cord (specific to country* with IEC type** plug)
[3]	1	D2049.EN .01	DS100M Manual

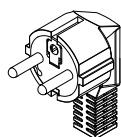

Z2611.000
3-pin Schuko
CE 7/7
IEC Lock**

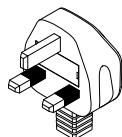

Z2611.010
3-pin GB
BS 1363A
IEC Lock**

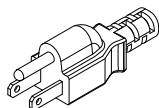

Z2611.020
3-pin USA
NEMA 5-15P
IEC Lock**

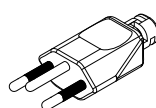

Z2611.030
3-pin Swiss
SEV1011
IEC Lock**

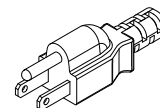

Z2611.040
3-pin Japan
NEMA 5-15P
IEC Std.**

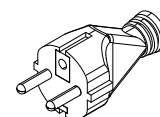

Z2611.050
3-pin South Korea
KS C8305
IEC Std.**

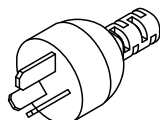

Z2611.060
3-pin Argentina
IRAM 2073
IEC Std.**

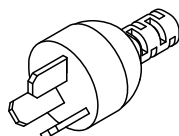

Z2611.070
3-pin China
GB 2099
IEC Std.**

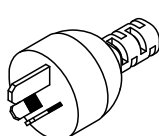

Z2611.080
3-pin Australia
AS 3112
IEC Std.**

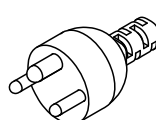

Z2611.100
3-pin Denmark
Afsnit 107-2-D1
IEC Std.**

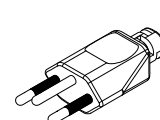

Z2611.110
3-pin Brazil
NBR 14136
IEC Std.**

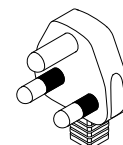

Z2611.120
3-pin South Africa
SANS 164-1
IEC Std.**

* Mains plug types and associated standards / ** IEC type

IEC Lock: Lockable IEC plug

IEC Std.: Standard IEC plug

(Illustrations are approximations only and not true to scale)

Power supply

Universal range switched mode power supply	
Mains connection	IEC type socket
Rated mains voltage	100 to 240 V, 50 - 60 Hz
Nominal power consumption	400 W

Thermal and Environmental conditions

IP class	IP20
Operating temperature range	0 °C to 50 °C
.....	32 °F to 122 °F
Storage temperature range	-20 °C to 70 °C
.....	-4 °F to 158 °F
Operating humidity range (rel. non-condensed)	10% to 85%
Storage humidity range (rel. non-condensed)	15% to 90%

Fan noise emission

Idle (@ 22 °C / 71.6 °F)	36 dB(A)
Full load (@ 22 °C / 71.6 °F)	42 dB(A)
Full load (@ 50 °C / 122 °F)	54 dB(A)

Dimensions and weight

Height x width x depth	3 RU x 19" x 481 mm
.....	3 RU x 19" x 18.93"
Weight	11 kg / 24.25 lb

Connections

ETHERNET	2 x RJ 45
.....	LAN 100/1000 Mbps
.....	OCA/AES70
.....	OSC
.....	SNMP
2 x USB	USB 3.0 port
AUDIO NETWORK	Milan™ audio network/AES67
.....	2 x RJ 45 for Milan™ PRImary/SECondary
.....	Gigabit only
MADI interface	Supported MADI channels: 1 ... 128 @ 48 kHz
.....	Supported MADI channels: 1 ... 96 @ 96 kHz
Physical MADI inputs	IN 1/IN 2/IN 3
MADI input channel blocks @ 48 kHz	1 - 32/33 - 64: IN 1
.....	65 - 96/97 - 128: IN 2
MADI input channel blocks @ 96 kHz	1 - 32: IN 1
.....	33 - 64: IN 2
.....	65 - 96: IN 3
.....	97 - 128: Not supported
WORD CLOCK	IN/OUT

Controls and indicators

Mains power switch	Rocker switch on rear panel
POWER	Push-button switch with integrated ring-LED indicator
Boot time	Appr.: 45 sec.

I/O

Sample rate for I/O	48/96 kHz
Inputs*	up to 128
Outputs*	up to 64
.....	* depending on dedicated license model size

Latency

Milan™ In to Out	0.875 ms @ 48 kHz
.....	1.51 ms @ 96 kHz
.....	plus Milan™ latency (1 or 2 ms Presentation Time Offset)

Input processing

Gain	-120 dB ... +24 dB
Polarity	0°/180°
EQ	8-band PEQ with high/low shelf
Delay	Up to 500 ms
Mute	On / Off

Matrix processing

Crosspoint Mute	On/Off
Crosspoint Level	-120 dB ... +10 dB
Crosspoint Delay	Up to 500 ms

Output processing

Gain	-120 dB ... +10 dB
Polarity	0°/180°
EQ	16-band PEQ with high/low shelf
Delay	Up to 500 ms
Mute	On/Off

En-Scene

Input sources	Up to 128
Positioning	Static or dynamic (moving)
Control	Manual or external
External control	OCA/AES70 and OSC

En-Space

Convolvers	Up to 144
Impulse response length	Up to 10 seconds

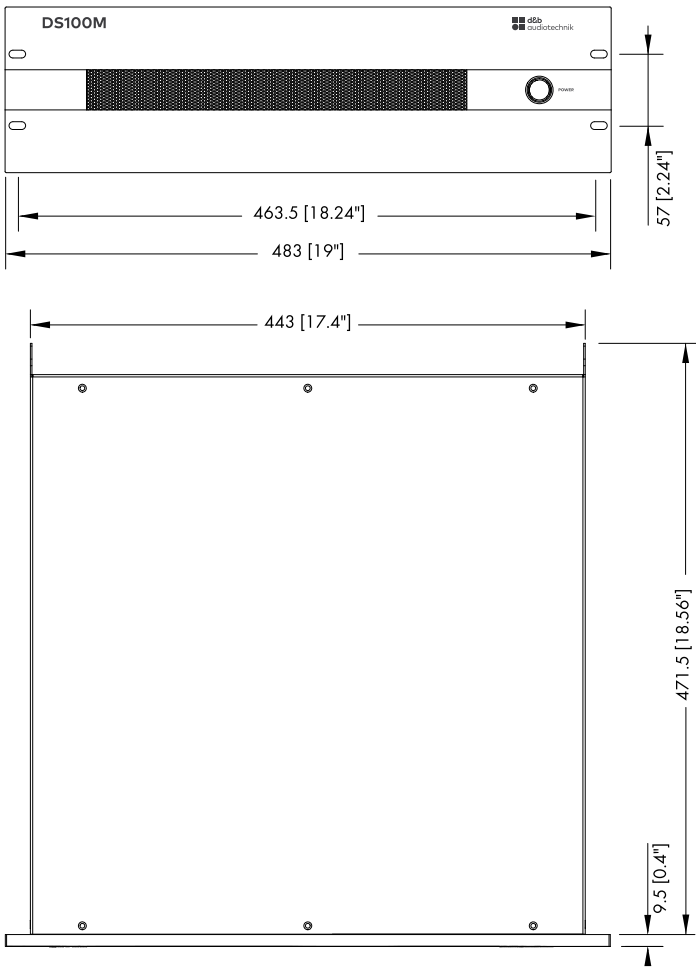

DS100M dimensions in mm [inch]

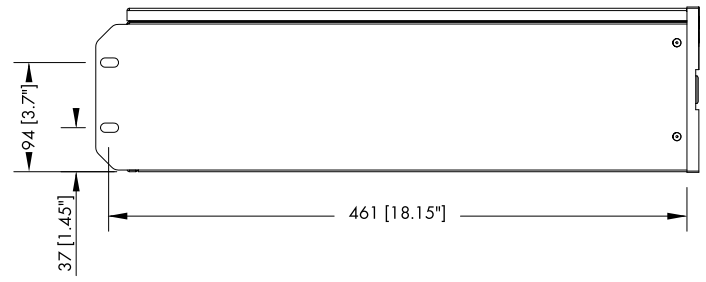

4.1 Overview

Connections

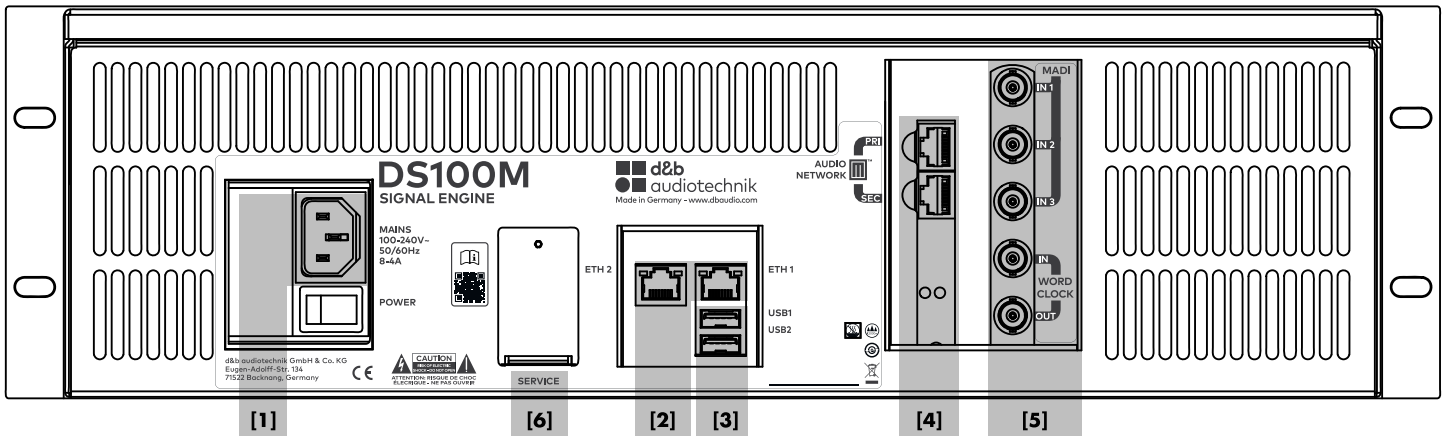

[1] IEC mains connector socket.
Refer to ⇒ Chapter 4.3.1 "Mains connection" on page 12.

[2] ETHERNET (LAN ports).
Refer to ⇒ Chapter 4.3.2 "ETH 1/ETH 2" on page 12.

[3] USB (USB 3.0 ports).
Refer to ⇒ Chapter 4.3.3 "USB" on page 13.

[6] SERVICE
For service purposes only.

[4] AUDIO NETWORK
Milan™ audio network.
Refer to ⇒ Chapter 4.3.4 "AUDIO NETWORK" on page 13.

[5] MADI interface.
Refer to ⇒ Chapter 4.3.5 "MADI interface" on page 14.

Controls and indicators

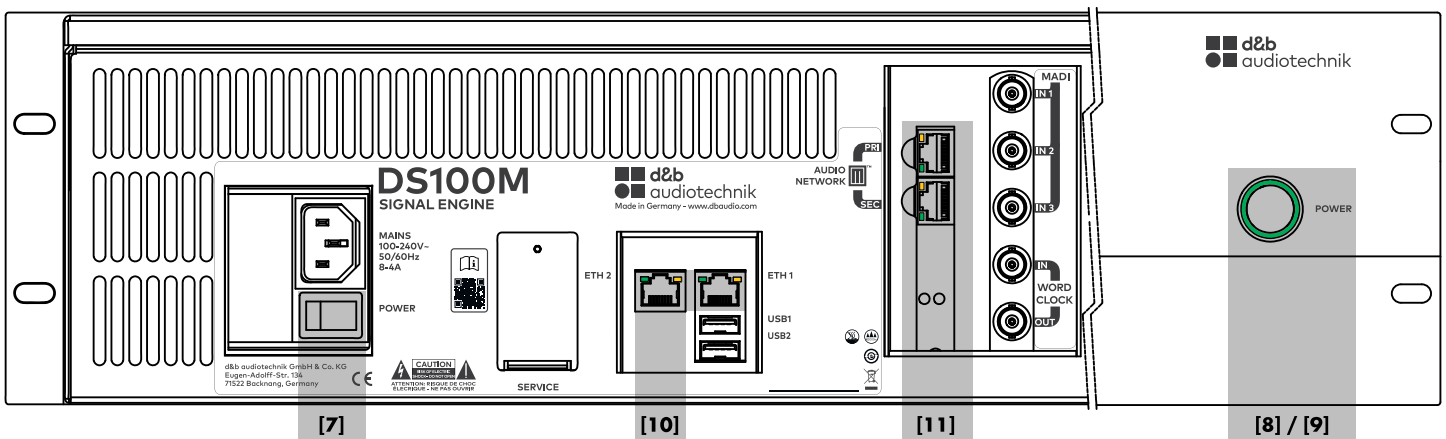

[7] Mains power switch.
Refer to ⇒ Chapter 4.4.1 "Mains power switch" on page 15.

[10] ETHERNET network indicators.
Refer to ⇒ Chapter 4.4.3 "ETHERNET indicators" on page 17

[11] AUDIO NETWORK indicators.
Refer to ⇒ Chapter 4.4.4 "AUDIO NETWORK indicators" on page 17.

[8] POWER button with integrated LED indicator.
[9] Refer to ⇒ Chapter 4.4.2 "POWER button and LED indicator" on page 15.

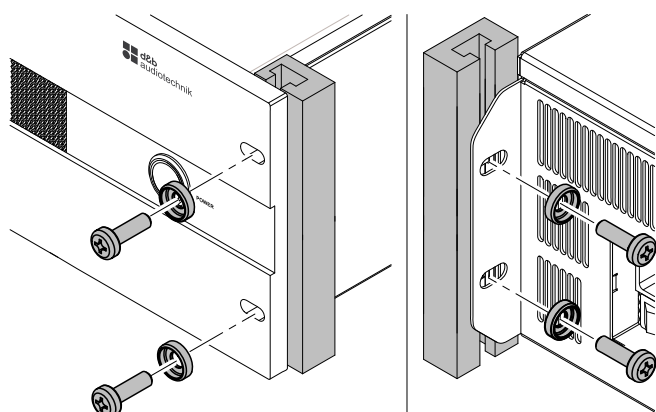

4.2 Rack mounting and cooling

Rack mounting

The enclosure is designed to fit standard 19" equipment racks or cabinets.

NOTICE!

When mounting the device into 19" equipment racks or cabinets, it is strongly recommended that you:

- **Always** fix the device at its **front AND rear rack ears** using appropriate rack mounting screws and U-washers, as shown in the graphic opposite.
 - Alternatively use shelves fixed to the inner sides of the equipment rack or cabinet.
-

Cooling

Thermal conditions are a vital factor to ensure operational safety of the device. The device is equipped with three internal fans that draw cool air from the front into the housing and channel the warm air towards the back of the device.

- Please ensure that adequate cool airflow is provided.
- Do not block or cover the front panel air intake or the vents on the rear panel.
- If the device is installed in sealed cabinets (e.g. in fixed installations), use additional fan modules with filters that can be easily replaced without opening the sealed cabinets.
- Do not rack up DS100M devices together with other devices producing additional heat with opposing airflow.

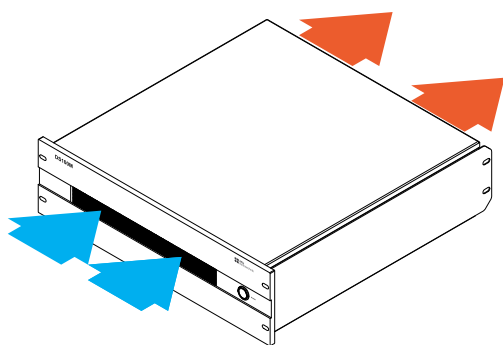

4.3 Connections

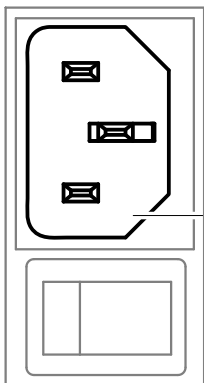
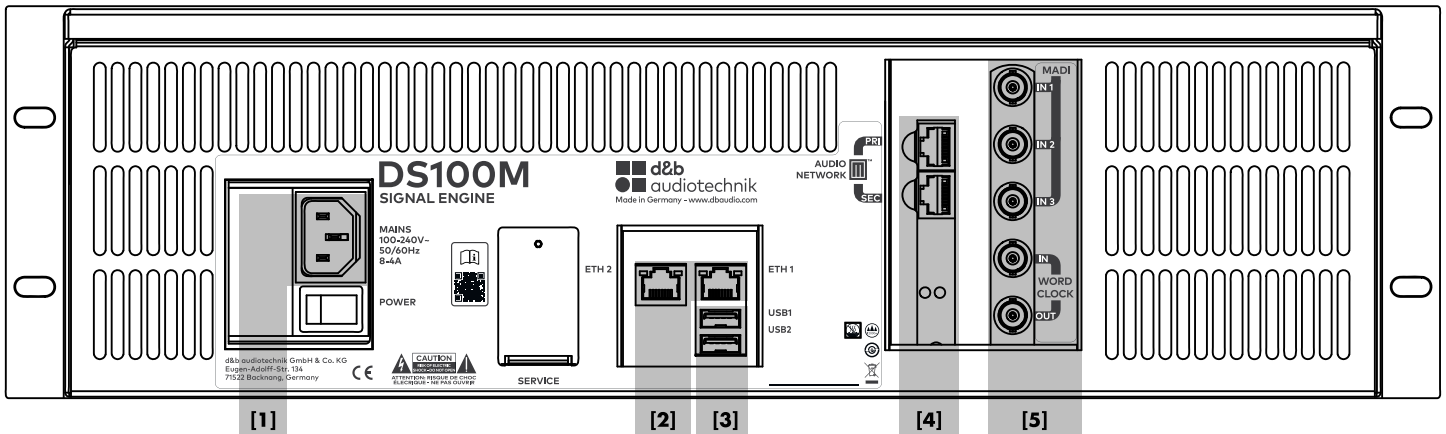

MAINS
100-240V~
50/60Hz
8-4A

[1]

POWER

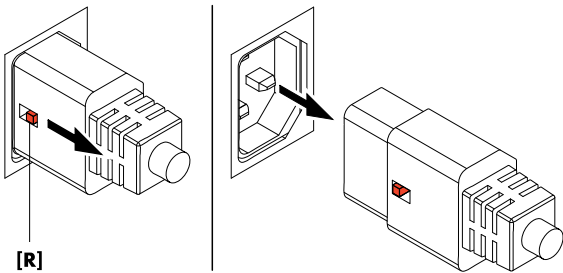

[R]

4.3.1 Mains connection



WARNING!

Potential risk of electric shock.

The device is a protective class 1 unit. A missing earth (ground) contact may cause dangerous voltages in the housing and controls and may lead to electric shock.

- Connect the device to mains power supplies with protective earth only.
- If there is any sign of obvious damage to the power cord and/or mains plug, do not use the power cord and replace it before further use.
- Please ensure the mains connector is accessible at any time to disconnect the device in case of malfunction or danger.

An IEC type mains connector socket [1] is fitted on the rear panel. An appropriate power cord with an IEC type mains plug is supplied with the device.

Before connecting the device to mains voltage, check that the mains voltage and frequency correspond to the specifications on the rating label next to the IEC type mains connector socket [1].

Lockable IEC type mains plug (IEC Lock)

Once the mains plug is connected, it is locked to avoid accidental disconnection of the device.

To disconnect the power cord, pull the release button [R] towards you and pull out the mains plug.

4.3.2 ETH 1/ETH 2

Two Ethernet ports (ETH 1/ETH 2 - 100/1000 Mbps/peer-to-peer) [2] are provided enabling remote control via Ethernet.

Note: The ETH 2 connector is currently disabled but is reserved for future feature implementations.

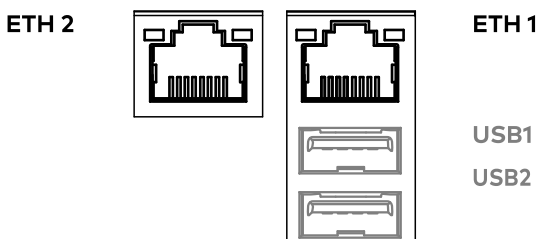

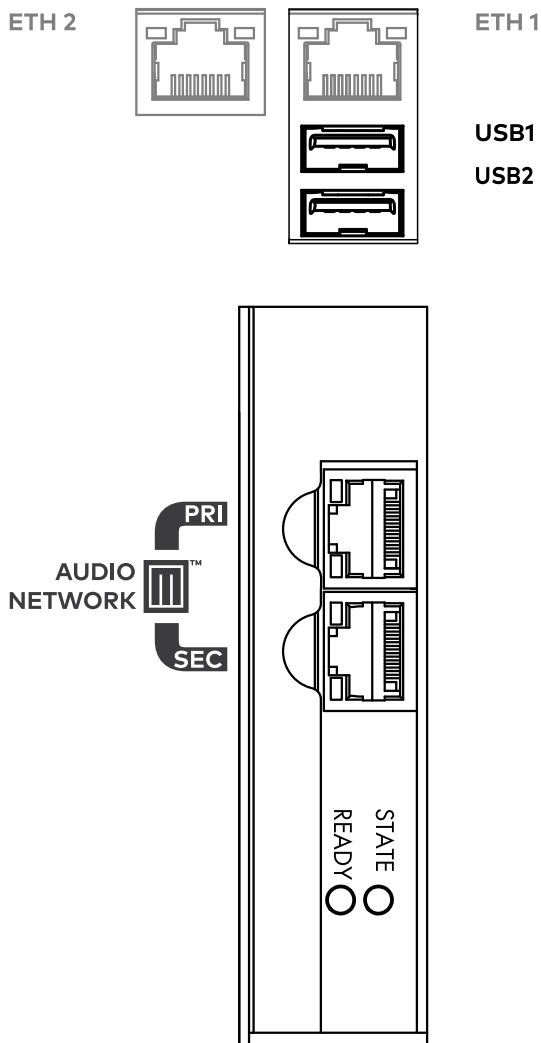

4.3.3 USB

Two USB 3.0 ports **[3]** are provided for future functionality.

4.3.4 AUDIO NETWORK

The DS100M provides a fully supported Milan™ audio network interface **[4]** (Gigabit only).

PRImary RJ45 Ethernet port (Prietary):
Used to connect the device to the primary network to transmit and receive audio.

SECondary RJ45 Ethernet port (Secondary):
Used to connect the device to a secondary network for redundancy.

Note: For the assignment/mapping of the DS100M processing channels, please refer to ⇒ Chapter 5 “Milan™/MADI interfacing” on page 18.

4.3.5 MADi interface

In addition the DS100M incorporates a fully supported MADi interface [5] which allows the corresponding MADi audio input sources to be transferred via the Milan™ audio network.

The assignment of the corresponding MADi input source blocks to the physical MADi inputs on the device are listed in the table below corresponding to the sampling of either 48 or 96 kHz.

Note: For the assignment/mapping of the DS100M processing channels, please refer to ⇒ Chapter 5 "Milan™/MADi interfacing" on page 18.

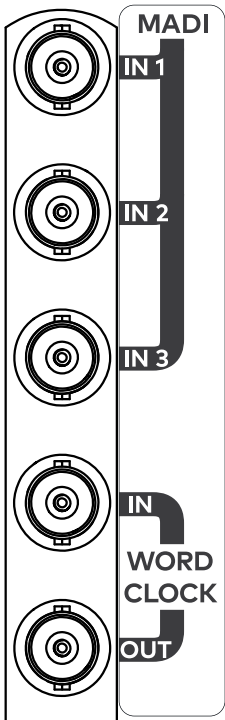

MADi input channel block	Physical MADi input
@ 48 kHz	
1 - 32	IN 1
33 - 64	IN 1
65 - 96	IN 2
97 - 128	IN 2
@ 96 kHz	
1 - 32	IN 1
33 - 64	IN 2
65 - 96	IN 3
97 - 128	- not supported -

WORD CLOCK

IN Receiving an external word clock signal.

OUT Providing the word clock signal.

4.4 Controls and indicators

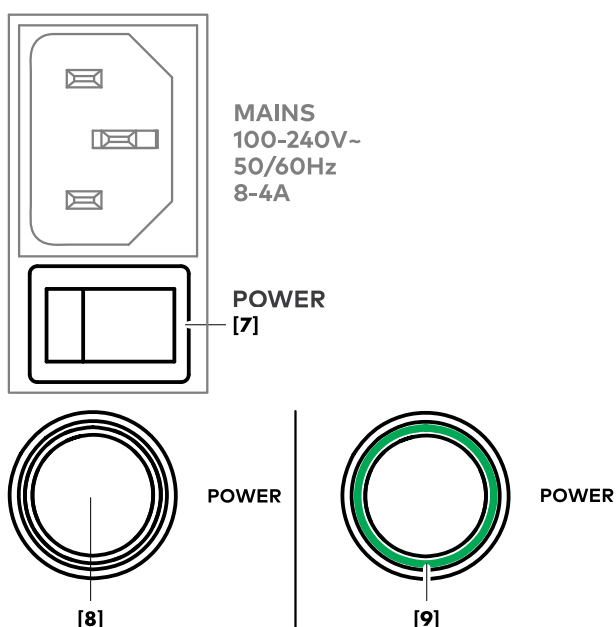
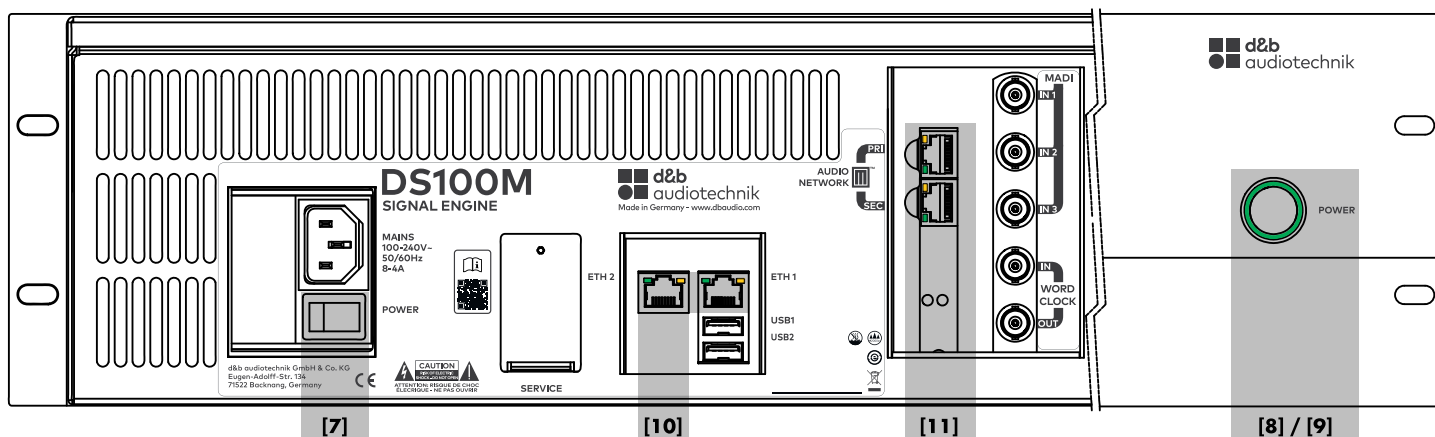

4.4.1 Mains power switch

The on/off rocker switch [7] is located on the rear panel.

OFF Mains isolation is not provided. The mains power supply is switched off but remains connected to the mains.

ON The mains power supply is switched on and the device is ready for operation.

4.4.2 POWER button and LED indicator

4.4.2.1 Switching on (boot up)

⇒ Provided the mains power switch [7] at the rear is switched on, pushing the POWER button [8] will boot up the device.

↳ The integrated LED indicator [9] illuminates green.

4.4.2.2 Device shut down/Device reset/System status



The POWER button serves to set/reset the device into dedicated system statuses by pressing the button a specified number of times within a time frame of 4 seconds.

Provided the device is powered on and fully booted, the table below details the desired device status, the necessary action/sequence and its result:

Device status	Action/Sequence	Result
Power down.	Press power button 2x.	Normal shut down.
Network to default settings.	Press power button 4x.	Network defaults applied: IPmode: DHCP+FB (Fallback). Fallback IPaddress: 192 . 168 . 1 . 100. IPmask: 255 . 255 . 255 . 0. RemID: Set to 0 . 01.
Network to DHCP+LL settings.	Press power button 5x.	DHCP+LL applied.
Reset device name and audio path.	Press power button 7x.	Reboot: <ul style="list-style-type: none"> ▪ Device name is reset to factory default. ▪ All inputs are reverted to Matrix mode. ▪ All input, matrix nodes and output processing is reset. ▪ Device Scenes and network/remote settings are not affected.

Trouble shooting

The LED indicator **[9]** also serves for basic trouble shooting purposes.

LED status	Description
Off	The system does not operate: <ul style="list-style-type: none"> ▪ No mains supply available. ▪ The mains power switch at the rear [7] is set to off (0). ▪ The POWER button [8] was not pressed. ▪ The mains power supply is faulty.
Illuminates green	<ul style="list-style-type: none"> ▪ Mains supply is available. ▪ The system is switched on and is operating.
Flashing 4 short flashes or 1 long flash followed by 4 short flashes, repeated. 	<ul style="list-style-type: none"> ▪ Power supply fault. Please contact your d&b Service Partner or Service Hub* .
Flashing 2 short flashes, repeated. 	<ul style="list-style-type: none"> ▪ Fault in CPU power supply. ▪ Fault in CPU or BIOS. Please contact your d&b Service Partner or Service Hub* .
Flashing permanently 	<ul style="list-style-type: none"> ▪ Milan™ I/O fault (Milan card). Please contact your d&b Service Partner or Service Hub* .

*The d&b website at www.dbaudio.com contains a list of all d&b Service Partners or Service Hubs responsible for your region.

Behavior after AC power interruption

If the AC power is interrupted, the device will remember its last power state and restore it when the AC power is re-established. This leads to the following behavior:

AC power interrupted while device is:	Behavior after re-establishing AC power:
On	Device powers up immediately: ⇒ Previous 'ON' state restored. ⇒ Device keeps 'ON' state.
Off	Device powers up immediately: ⇒ Previous 'OFF' state restored. ⇒ Device shuts down.

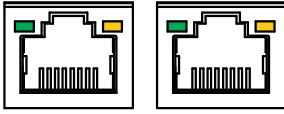

ETH 2



ETH 1



4.4.3 ETHERNET indicators

Status LEDs

-  **Link status / activity LED**
Solid green: Link established.
Flashing: Link activity.
-  **Gigabit link status LED**
Solid orange: Established Gigabit Ethernet link.

4.4.4 AUDIO NETWORK indicators

Audio network LEDs (PRI/SEC)

-  **Gigabit link status LED:**
Solid orange: Established Gigabit Ethernet link.
-  **Link status LED:**
Solid green: Card present.

Status LEDs

The status LEDs indicate the system and ATDECC identification status:

- READY** (●) Solid orange: AVB daemon is started and Milan™ communication is enabled.
- STATE** (○/⚙️) Normally off.
Flashing white: ATDECC identification active.

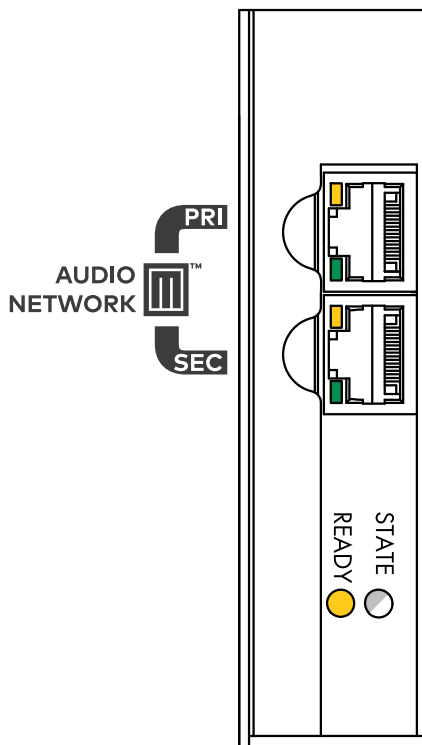

The DS100M provides Milan™ audio networking as well as MADI audio inputs within one device.

This allows either Milan™ or MADI audio input sources to be processed correspondingly.

The DS100M processing provides a total of 128 possible audio input sources.

To these input sources (divided into two blocks 1 - 32 and 33 - 64), you can assign corresponding blocks of 32 input sources to define from what input source (either Milan™ or MADI / Radio button in R1) the signals should originate.

Note: When using MADI input sources, either in combination with Milan™ input sources or pure MADI input sources, you have to apply the necessary clocking externally.

The assignment/mapping is performed in R1.

Example

In the screen shot below, MADI input source block 33 - 64 is selected for the DS100M input source block 1 - 32 and Milan™ input source block 1 - 32 is selected for the DS100M input source block 33 - 64.

General	Input source	Inputs	Matrix	Outputs	Info	Diagnostics
1-32	MADI 1-32	MADI 33-64	MADI 65-96	MADI 97-128	Milan 1-32	Milan 33-64
33-64	MADI 1-32	MADI 33-64	MADI 65-96	MADI 97-128	Milan 1-32	Milan 33-64

DS100M input source assignment/mapping in R1

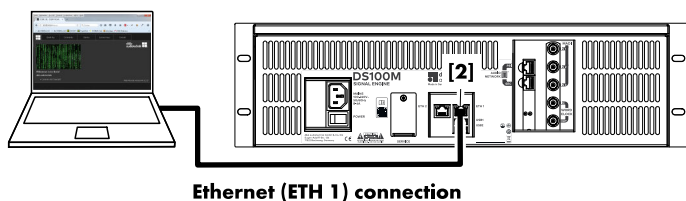

6.1 Physical setup

Simply connect the LAN connector port of your computer to the ETHERNET [2] (ETH 1) connector of the device.

6.2 Direct connection

To enable access via the Web Remote interface, proceed as follows:

By factory default, the IP address is set to 192.168.1.100.

To access the device, manually assign an IP address to the computer in your network in the same subnet as the device.

Proceed as follows:

1. Navigate to the network settings of your computer associated with your network adapter.
2. Open the corresponding network properties dialog.
3. Enter a static IP address in the same subnet as the device:
IP address: e.g. 192.168.1.101
Subnet mask: 255.255.255.0
4. Confirm the changes and close the network properties dialog.
5. To display the Web Remote interface page of the device, enter its IP address (192.168.1.100) in the address bar of your web browser.

6.3 Web Remote interface

A Web Remote interface is integrated which provides direct access to the DS100 using a standard web browser.

Note: The DS100 can only be accessed after connecting the device to a computer via Ethernet. However, this requires to manually set a static IP address on the PC network interface. Connect the DS100 and the computer to the same Ethernet network.

Recommended and tested browsers:

- Windows:**
- Firefox V22.0 or higher
 - Microsoft Internet Explorer V11 or higher
 - Microsoft Edge V12 or higher
 - Google Chrome V21 or higher
 - Opera V15 or higher
- macOS:**
- Safari V6.0 or higher
 - Firefox V22.0 or higher
 - Google Chrome V21 or higher
 - Opera V15 or higher
- iOS:**
- iOS 6 or higher
- Android:**
- Mobile Firefox V27.0 or higher
 - Android Browser V4.4 or higher

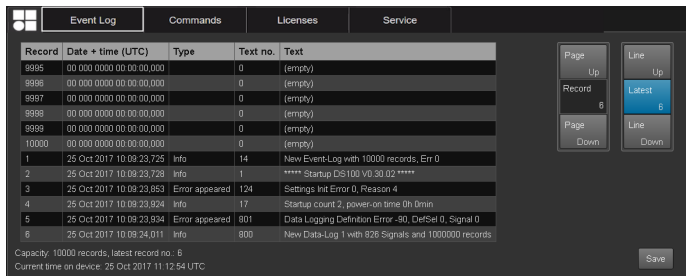
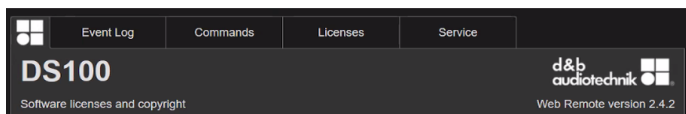

6.4 Web Remote interface page

The Web Remote interface page is split into three tabs: the «Event Log», «Commands» and «Licenses» tabs.

6.4.1 Event Log tab

The «Event Log» stores a maximum of 10000 records. Once the maximum number of records is reached, the system starts deleting the first ones ⇒ Ring buffer.

The number of records displayed depends on the size of the browser window.

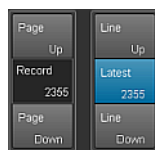

Located on the right-hand side of the record list are various Navigation buttons allowing you to scroll through the list using the «Page Up/Down» or «Line Up/Down» buttons or by directly jumping to the «Latest» record.

In addition, the editable «Record» field allows you to enter a dedicated record number. The corresponding record will be displayed at the very bottom of the record list.

Storage option

In addition, a storage option is provided which allows you to store the Event Log data locally. This is mainly intended for service and/or troubleshooting purposes.

To save the Event Log data locally, proceed as follows:

1. Select the «Save» button (Save) at the bottom right corner of the web browser window.
 - ↳ A corresponding dialog will pop up providing you with a drop-down list from which you can select either the number («Last [n]») of records or «All» records to be saved.
2. Choose the desired option from the drop-down list and select «Save».
 - ↳ The Event Log data will be downloaded and the download progress will be displayed.

Once the download is completed, a corresponding message will be displayed.
3. Select «Save» to store the Event Log data locally.
 - ↳ Your web browser will display the corresponding dialog and the file will be saved as **Event . log** to the local download directory you have specified in the download settings of your browser.

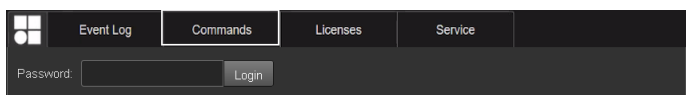
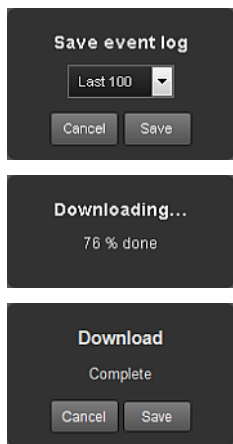

6.4.2 Commands tab

This functionality is intended for service purposes only.

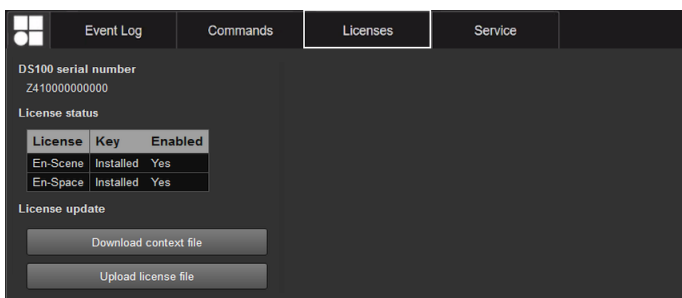

6.4.3 Licenses tab

Apart from the serial number of the device (⇒ «DS100 serial number»), the «Licenses» tab provides an overview of the licenses installed on the device (⇒ «License status») and allows new licenses or license updates to be uploaded to the device (⇒ «License update»).

6.4.3.1 License update

To upload/exchange license keys, proceed as follows:

1. Select the «Download context file» button.
 - ↳ Your web browser will display the corresponding dialog and the file will be saved as:

```
dbaudio-
DS100_[SerialNumber]_[LicenseKey]_[Date].
rac
```

 to the local download directory you have specified in the download settings of your browser.
2. Send this file via email to your d&b sales partner.
 - ↳ He will then send you the new license file:

```
dbaudio-
DS100_[SerialNumber]_[LicenseKey]_[Date].
rau.
```
3. Once you have received the file, select the «Upload license file» button.
 - ↳ Your web browser will display the corresponding dialog.

Once the license file is uploaded you can enable or disable your license keys within R1.

Event Log Commands Licenses Service

Password: Login

Logged in as 'User 1' Logout

Backup

Download backup file from device

Restore

Upload backup file to device

Start editing the remote settings (if necessary), then activate backup.

Remote ID 0.63

IP mode DHCP + LL

IP address 192.168.1.20 Device subnet will change

IP mask 255.255.255.0

IP gateway 192.168.1.1

Activate backup file on device

Log file collection

Download log file collection

6.4.4 Service tab

Service tab

The «Service» tab provides a «Backup»/«Restore» function for the complete device configuration.

Note:

Login

To access the service functions, you first have to log in.

If the device is locked by password protection, use the corresponding password to log in. If no password protection is applied, use "dbaudio" as a password.

Backup

- ⇒ Select the «Download backup file from device» button to store the backup file (*.backup) locally.
 - ↳ Your web browser will display the corresponding dialog and the file will be saved to the local download directory you have specified in the download settings of your browser.

Restore

1. Select the «Upload backup file to device» button to upload the backup file onto the device.
 - ↳ Your web browser will display the corresponding dialog.

Once the backup file is uploaded, the «Remote ID» and «IP settings» become accessible and can be edited, if necessary by simply clicking into the corresponding input field..
2. As a final step, select the «Activate backup file on device» button to apply the backup and remote settings.

Log file collection

For service or trouble shooting purposes, a log file collection can be downloaded.

- ⇒ Select the «Download log file collection» button to store the collection file (*.logpack.) locally.
 - ↳ Your web browser will display the corresponding dialog and the file will be saved to the local download directory you have specified in the download settings of your browser.

Logout

To exit the «Service» tab functions, click the «Logout» button at the top.

7.1 Service



CAUTION!
Potential risk of explosion.

The device incorporates a lithium battery which may cause danger of explosion if not replaced correctly.

Refer replacement only to qualified service personnel authorized by d&b audiotechnik.

Do not open the device. No user serviceable parts inside. In case of any damage do not operate the device under any circumstances.

Refer servicing only to qualified service personnel authorized by d&b audiotechnik. In particular if:

- objects or liquids have entered the device.
- the device does not operate normally.
- the device was dropped or the housing is damaged.

7.2 Maintenance and care

The air-intake at the front of the device is covered by a mesh-filter-inlay. To ensure proper cooling the mesh-filter should be regularly cleaned from dust and moisture.

For this purpose, proceed as follows:

1. Grab and take off the mesh-filter-inlay as shown in the graphic opposite.
2. Clean the filter from any dust and moisture.
3. Insert the filter-inlay to the bottom edge of the air-intake slot.
4. Push-in the top edge of the filter-inlay and spread out the filter-inlay to both sides as shown in the graphic opposite.
5. Finally ensure the filter-inlay is properly fitted in place.

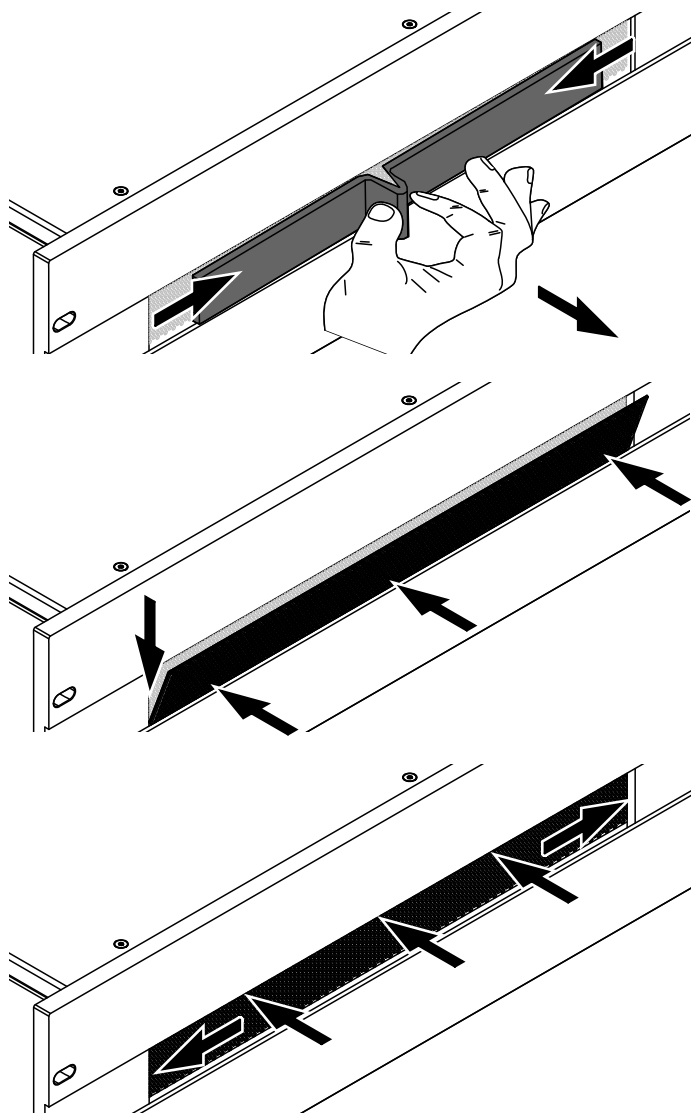



8.1 Declaration of Conformity

This declaration applies to:

d&b Z4102 DS100M Signal Engine

by d&b audiotechnik GmbH & Co. KG.

All product variants are included, provided they correspond to the original technical version and have not been subject to any later design or electromechanical modifications.

We herewith declare that said products are in conformity with the provisions of the respective directives including all applicable amendments.

Detailed and applicable declarations are available on request and can be ordered from d&b or downloaded from the d&b website at www.dbaudio.com.



8.2 WEEE Declaration (Disposal)

Electrical and electronic equipment must be disposed of separately from normal waste at the end of its operational lifetime.

Please dispose of this product according to the respective national regulations or contractual agreements. If there are any further questions concerning the disposal of this product, please contact d&b audiotechnik.

WEEE-Reg. -Nr. DE: 13421928

8.3 Licenses and Copyright

This device includes software components released under different open source licenses. These components are supplied together with the d&b firmware.

This page provides an overview of the open source software used in this product. As required by the GPL and LGPL licenses, we will send you a copy of the used source code on request. If you would like to obtain a copy, please contact us by mail to: software.support@dbaudio.com

8.4 Certifications



Avnu DS100M certification

Certification ID: [316](#)

Date Certified: 2024-04-05

Supported Segments: Milan™

Product Classes: End Station

Product Type: Matrix Mixer

